

SYSTEME ÉCLAIRAGE TABLEAU AGA-LED®

BILDERBELEUCHTUNGSSYSTEM AGA-LED®

AGA-LED® PICTURE LIGHTING SYSTEM

TMLAL IP44

AGA-LED® A-6 OU A-10

RIGID LOOP CONNECTOR

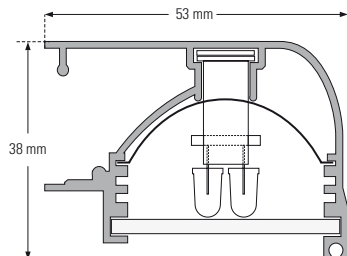

AGA-LED® A-10
rigid loop connector
2800K, 5000K / 60'000h



Photo: TMLAL IP20 avec AGA-LED® B-10 lighting units
rigid loop connector / 24V / 1W

Système d'éclairage de tableaux, linéaire basse tension à courant stabilisé utilisant des unités lumineuses AGA-LED® A-6 ou A-10.

Compris dans le luminaire

- Profilé extrudé en aluminium éloxé vieil or (voir pictogrammes ci-dessus).
- 2 conducteurs plats isolés de 8mm² chacun, (brevet mondial B'Light®).
- Supports BXA et caches blancs CMB pour unités lumineuses AGA-LED® rigid loop connector.
- Réflecteur intensif RI.
- Embouts.
- Tiges de support en aluminium, TIGE-10, anodisées vieil or.
- Câbles.
- Verre transparent VAT.

Non compris

- Alimentation stabilisée 18PU02 de 24V-25W : voir p. 234.
- Unités lumineuses AGA-LED® : voir p.218.
- Fixations murale BFTH-10.
- Boîtier pour transformateur.

Câble d'alimentation

- La section du câble dépend de la distance entre le transformateur et le luminaire (COS-1 incluses).

Alimentation

- Ce luminaire est livré prêt à l'emploi.

Applications

- Pour tous tableaux.

Finition sur demande

- Thermolaquage, poudrage RAL, éloxage, chromage ou dorage.

Accessoires

- Voir p. 209.

Recommandations et précautions

- Voir p. 245.

Données photométriques

- Téléchargeables sur notre site web : www.agabekov.com.

Lineares Niedervolt-Bilderbeleuchtungssystem mit stabilisiertem Strom, mit Leuchteinheiten AGA-LED® A-6 oder A-10

Die Leuchtausführung umfasst

- Eloxiertes Aluminiumextrusionsprofil altgold (siehe Piktogramme oben).
- 2 isolierte Flachleiter von je 8 mm² (Weltpatent B'Light®).
- BXA-Halter und CMB weiße Sichtabdeckungen für AGA-LED® Leuchteinheiten rigid loop connector.
- Intensivreflektor RIP.
- Endstücke.
- Haltebügel aus Aluminium, TIGE 10 altgold eloxiert.
- Kabel.
- VAT Glas klar.

Die Leuchtausführung umfasst nicht

- Stabilisierte Stromversorgung 18PU02, 24 V-25W : siehe S. 234.
- Leuchteinheiten AGA-LED® : siehe S. 218.
- Wandbefestigungen BFTH-10.
- Gehäuse für Transformator.

Versorgungskabel

- Der Kabelquerschnitt ist vom Abstand zwischen dem Transformator und dem Beleuchtungssystem abhängig (COS-1 enthalten).

Versorgung

- Diese Leuchte wird in betriebsbereitem Zustand geliefert.

Anwendungen

- Für alle Bilder

Ausführungen auf Anfrage

- Thermolackiert, RAL pulverbeschichtet, eloxiert, verchromt oder vergoldet

Zubehör

- Siehe S. 209.

Empfehlungen und Vorsichtsmassnahmen

- Siehe S. 245.

Photometrische Daten

- Auf unserer Website herunterhalten : www.agabekov.com.

Low voltage current stabilised linear lighting system for pictures, using AGA-LED® A-6 or A-10 lighting units.

Included

- Extruded antique gold anodised aluminium profile (see illustrations above).
- 2 insulated flat conductors of 8mm² each (B'Light® worldwide patented).
- BXA holders and white CMB shrouds for AGA-LED® rigid loop connector lighting units.
- RI narrow angle reflector.
- End-caps.
- Aluminium support rods (TIGE-10), antique gold anodised.
- Cables.
- VAT clear lens.

Not included

- 18PU02 stabilized power-supply, 24V- 25W : see p. 234.
- AGA-LED® lighting units : see p. 218.
- BFTH-10 wall mounting clips.
- Transformer box.

Power cable

- The cable section depends on the distance between transformer and luminaire (COS-1 included).

Power feed

- This luminaire is supplied ready to use.

Applications

- For pictures of all kinds.

Finish on request

- Thermo-enamelling, powder coating RAL, colour anodising, chromium or gold plating.

Accessories

- See p. 209.

Recommendations et precautions

- See p. 245.

Photometric data

- Downloadable on our website : www.agabekov.com.



Prix: voir référence ou nom dans la liste de prix
Preise: Siehe Artikel-Nr. oder Modellbezeichnung in der Preisliste
Price: see under reference or name in price list

AGA-LED® lighting units
USA, Europe, Japan patents

SYSTEME ÉCLAIRAGE TABLEAU AGA-LED®

BILDERBELEUCHTUNGSSYSTEM AGA-LED®

AGA-LED® PICTURE LIGHTING SYSTEM

TMLAL IP44

TMLAL IP44

AGA-LED® **A-6** RIGID LOOP CONNECTOR

24V / 0.5W / 2800K, 5000K

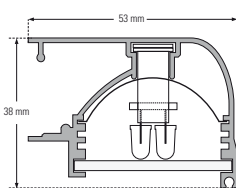

Données et puissances - Daten und Leistungen - Power and other data

Réf.	Lenght	N° of lighting units	Volt	Power
TMLAL-0670	670mm	11	24V	5.5W
TMLAL-1000	1000mm	17	24V	8.5W
TMLAL-0000	fabriqué sur mesure - prix sur demande / Massanfertigung - Preise auf Anfrage / made to measure - price on request			

AGA-LED® A-6 luminous flux :

2800K : **24 lm**

5000K : **30 lm**

TMLAL IP44

AGA-LED® **A-10** RIGID LOOP CONNECTOR

24V / 1W / 2800K, 5000K

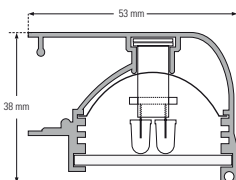

Données et puissances - Daten und Leistungen - Power and other data

Réf.	Lenght	N° of lighting units	Volt	Power
TMLAL-0670	670mm	11	24V	11W
TMLAL-1000	1000mm	17	24V	17W
TMLAL-0000	fabriqué sur mesure - prix sur demande / Massanfertigung - Preise auf Anfrage / made to measure - price on request			

AGA-LED® A-10 luminous flux :

2800K : **40 lm**

5000K : **50 lm**



IP44



Prix: voir référence ou nom dans la liste de prix
 Preise: Siehe Artikel-Nr. oder Modellbezeichnung in der Preisliste
 Price: see under reference or name in price list

AGA-LED® lighting units
 USA, Europe, Japan patents

SYSTÈME ÉCLAIRAGE TABLEAU AGA-LED®

BILDERBELEUCHTUNGSSYSTEM AGA-LED®

AGA-LED® PICTURE LIGHTING SYSTEM

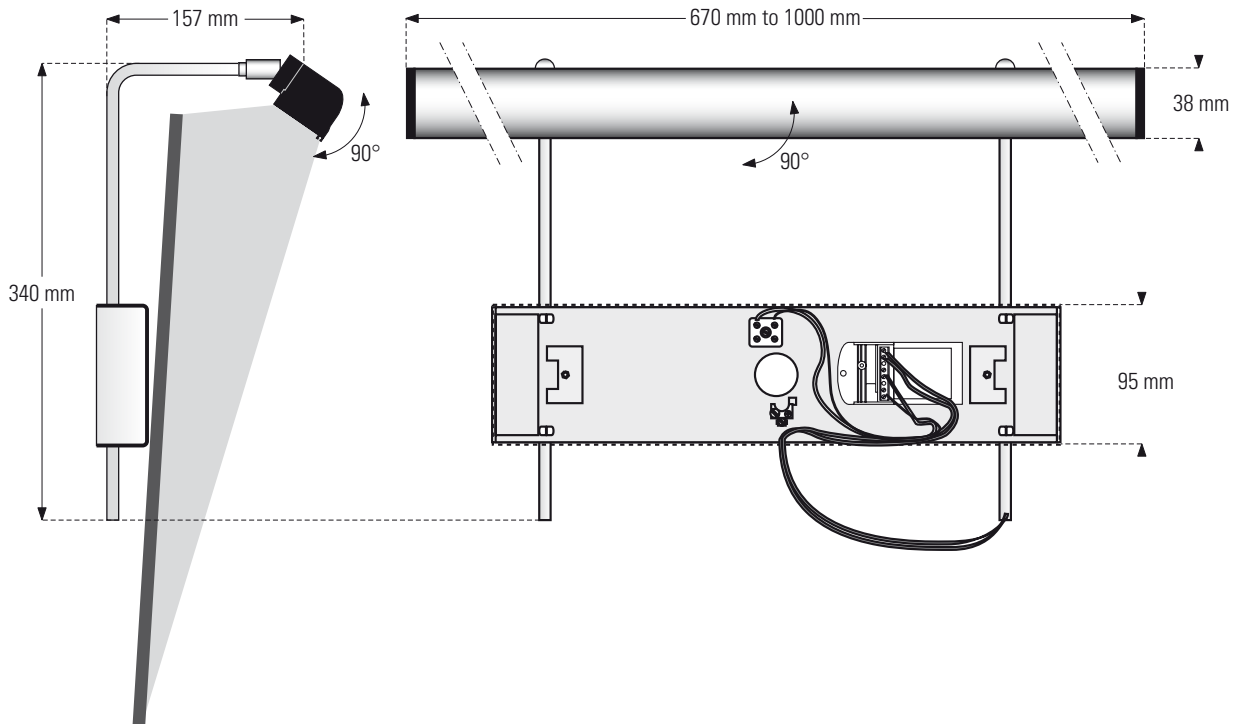
TMLAL IP44**ACCESSOIRES POUR SYSTÈME ÉCLAIRAGE TABLEAU AGA-LED®**

ZUBEHÖR FÜR DAS BILDERBELEUCHTUNGSSYSTEM AGA-LED®

ACCESSORIES FOR AGA-LED® PICTURE LIGHTING SYSTEM

TMLAL IP44

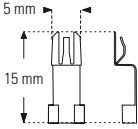
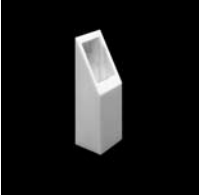
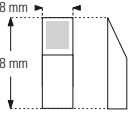
			TMLAL	
BXA		<ul style="list-style-type: none"> ▪ Support pour AGA-LED® rigid loop connector ▪ Halter für AGA-LED® rigid loop connector ▪ Holder for AGA-LED® rigid loop connector 		●
CMB		<ul style="list-style-type: none"> ▪ Cache pour support BX A ▪ Sichtabdeckung für BX A-Halter ▪ White shroud for BX A 		●

● Compris dans le luminaire
Die Leuchtenausführung umfasst
Included

●● Non compris dans le luminaire
Die Leuchtenausführung umfasst nicht
Not included

Prix: voir référence ou nom dans la liste de prix
Preise: Siehe Artikel-Nr. oder Modellbezeichnung in der Preisliste
Price: see under reference or name in price list







AGA-LED® lighting units
USA, Europe, Japan patents

ACCESSOIRES POUR SYSTÈME ÉCLAIRAGE TABLEAU AGA-LED®

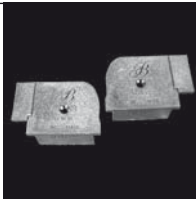
ZUBEHÖR FÜR DAS BILDERBELEUCHTUNGSSYSTEM AGA-LED®

ACCESSORIES FOR AGA-LED® PICTURE LIGHTING SYSTEM

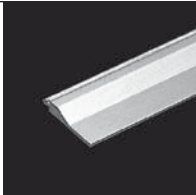
TMLAL IP44

			TMLAL								
ELR-G/ ELR-D		<ul style="list-style-type: none"> ▪ Embout polycarbonate noir ▪ Endstück Polycarbonat schwarz ▪ Black polycarbonate end-cap 	●								
TIGE-10		<ul style="list-style-type: none"> ▪ Tige de support long. 340mm Ø10mm ▪ Haltebügel Länge 340mm Ø10mm ▪ Rod support length 340mm Ø10mm 	●								
RI		<ul style="list-style-type: none"> ▪ Réflecteur intensif chromé 24° ▪ Verchromter Intensivreflektor 24° ▪ Narrow angle (24°) chrome-plated reflector 	●								
VAT		<ul style="list-style-type: none"> ▪ Verre transparent en Lexan® ▪ Glas klar aus Lexan® ▪ Clear protective lens in Lexan® <table border="0" style="margin-left: auto; margin-right: auto;"> <thead> <tr> <th style="text-align: left;">Code</th> <th style="text-align: left;">Lenght</th> </tr> </thead> <tbody> <tr> <td>VAT-0670</td> <td>670mm</td> </tr> <tr> <td>VAT-1000</td> <td>1000mm</td> </tr> <tr> <td>VAT-0000</td> <td>made to measure</td> </tr> </tbody> </table>	Code	Lenght	VAT-0670	670mm	VAT-1000	1000mm	VAT-0000	made to measure	●
Code	Lenght										
VAT-0670	670mm										
VAT-1000	1000mm										
VAT-0000	made to measure										
CF		<ul style="list-style-type: none"> ▪ Cache frontal anti-éblouissement ▪ Blendschutz-Frontabdeckung ▪ Anti-glare front visor <table border="0" style="margin-left: auto; margin-right: auto;"> <thead> <tr> <th style="text-align: left;">Code</th> <th style="text-align: left;">Lenght</th> </tr> </thead> <tbody> <tr> <td>CF-0670</td> <td>670mm</td> </tr> <tr> <td>CF-1000</td> <td>1000mm</td> </tr> <tr> <td>CF-0000</td> <td>made to measure</td> </tr> </tbody> </table>	Code	Lenght	CF-0670	670mm	CF-1000	1000mm	CF-0000	made to measure	● ●
Code	Lenght										
CF-0670	670mm										
CF-1000	1000mm										
CF-0000	made to measure										
BFTH-10		<ul style="list-style-type: none"> ▪ Fixation murale horiz. pour tige Ø10mm ▪ Horizontale Wandbefestigung für Bügel Ø10mm ▪ Horizontal wall mounting for rods Ø10mm 	● ●								
BOX		<ul style="list-style-type: none"> ▪ Boîtier pour transformateur ▪ Gehäuse für Transformator ▪ Transformer box 	● ●								

● Compris dans le luminaire
Die Leuchtenausführung umfasst
Included

●● Non compris dans le luminaire
Die Leuchtenausführung umfasst nicht
Not included

Prix: voir référence ou nom dans la liste de prix
Preise: Siehe Artikel-Nr. oder Modellbezeichnung in der Preisliste
Price: see under reference or name in price list

AGA-LED® lighting units
USA, Europe, Japan patents