

SYSTEME ÉCLAIRAGE TABLEAU AGA-LED®

BILDERBELEUCHTUNGSSYSTEM AGA-LED®

AGA-LED® PICTURE LIGHTING SYSTEM

TMT-AL IP20

AGA-LED® B-3, B-6 OU B-10

RIGID LOOP CONNECTOR

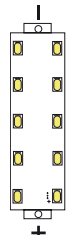
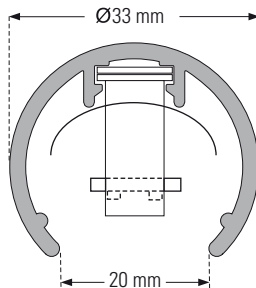

AGA-LED® B-10
rigid loop connector
2800K, 5000K / 60'000h



Photo: TMT-AL IP20 avec AGA-LED® B-10 lighting units
rigid loop connector / 24V / 1W

Système d'éclairage de tableaux, linéaire basse tension à courant stabilisé utilisant des unités lumineuses AGA-LED® B-3, B-6 ou B-10.

Compris dans le luminaire

- Profilé extrudé en aluminium éloxé de forme tubulaire (voir pictogrammes ci-dessus).
- 2 conducteurs plats isolés de 8mm² chacun, (brevet mondial B'Light®).
- Supports BXA et caches blancs CMB pour unités lumineuses AGA-LED® rigid loop connector.
- Réflecteur intensif RIP.
- TMTE embouts en aluminium.
- Tiges de support en aluminium, (TIGE-8) anodisées.
- Plaque transparente, pour la fixation du transformateur.
- Fixations murale BFTV.
- Câbles 1m sans prises.

Non compris

- Alimentation stabilisée 18PU02 de 24V-25W : voir p. 234.
- Unités lumineuses AGA-LED®: voir p. 218.
- Tige de support supplémentaire pour une longueur supérieur de 1000mm.

Câble d'alimentation

- La section du câble dépend de la distance entre le transformateur et le luminaire (COS-1 incluses).

Alimentation

- Ce luminaire est livré prêt à l'emploi.

Applications

- Pour tous tableaux.

Finition sur demande

- Thermolaquage, poudre RAL, éloxage, chromage ou dorage.

Accessoires

- Voir p. 205.

Recommandations et précautions

- Voir p. 245.

Données photométriques

- Téléchargeables sur notre site web : www.agabekov.com.

Lineares Niedervolt-Bilderbeleuchtungssystem mit stabilisiertem Strom, mit Leuchteinheiten AGA-LED® B-3, B-6 oder B-10.

Die Leuchtausführung umfasst

- Röhrenförmiges natureloxiertes Aluminiumextrusionsprofil (siehe Piktogramme oben).
- 2 isolierte Flachleiter von je 8 mm² (Weltpatent B'Light®).
- BXA-Halter und CMB weisse Sichtabdeckungen für AGA-LED® Leuchteinheiten rigid loop connector.
- Intensivreflektor RIP.
- TMTE Endstücke aus Aluminium.
- Haltbügel aus Aluminium (TIGE-8), eloxiert
- Transparente Sockelplatte zur Befestigung des Transformators.
- BFTV Wandbefestigungen.
- Kabel und Steckdosen.

Die Leuchtausführung umfasst nicht

- Stabilisierte Stromversorgung 18PU02, 24 V-25: siehe S. 234.
- Leuchteinheiten AGA-LED®: siehe S. 218.
- Zusätzlicher Haltebügel für Systemlängen über 1000 mm

Versorgungskabel

- Der Kabelquerschnitt ist vom Abstand zwischen dem Transformator und dem Beleuchtungssystem abhängig (COS-1 enthalten).

Versorgung

- Diese Leuchte wird in betriebsbereitem Zustand geliefert.

Anwendungen

- Für alle Bilder.

Ausführungen auf Anfrage

- Thermolackiert, RAL pulverbeschichtet, eloxiert, verchromt oder vergoldet.

Zubehör

- Siehe S. 205.

Empfehlungen und Vorsichtsmassnahmen

- Siehe S. 245.

Photometrische Daten

- Auf unserer Website herunterhalten : www.agabekov.com.

Low voltage current stabilised linear lighting system for pictures, using AGA-LED® B-3, B-6 or B-10 lighting units.

Included

- Extruded anodised aluminium tubular profile (see illustrations above).
- 2 insulated flat conductors of 8mm² each (B'Light® worldwide patented).
- BXA holders and white CMB shrouds for AGA-LED® rigid loop connector lighting units.
- RIP intensive reflector.
- TMTE aluminium end-caps.
- Anodised aluminium support rods (TIGE-8).
- Transparent plate for mounting transformer.
- BFTV wall mounts.
- Cables and plugs.

Not included

- 18PU02 stabilised power-supply, 24V- 25W : see p. 234.
- AGA-LED® lighting units : see p. 218.
- Additional support rod for length greater than 1000mm.

Power cable

- The cable section depends on the distance between transformer and luminaire (COS-1 included).

Power feed

- This luminaire is supplied ready to use.

Applications

- For pictures of all kinds.

Finish on request

- Thermo-enamelling, powder coating RAL, colour anodising, chromium or gold plating.

Accessories

- See p. 205.

Recommendations et precautions

- See p. 245.

Photometric data

- Downloadable on our website : www.agabekov.com.



Prix: voir référence ou nom dans la liste de prix
Preise: Siehe Artikel-Nr. oder Modellbezeichnung in der Preisliste
Price: see under reference or name in price list

AGA-LED® lighting units
USA, Europe, Japan patents

SYSTEME ÉCLAIRAGE TABLEAU AGA-LED®

BILDERBELEUCHTUNGSSYSTEM AGA-LED®

AGA-LED® PICTURE LIGHTING SYSTEM

TMT-AL IP20

TMT-AL IP20

AGA-LED® B-3 RIGID LOOP CONNECTOR

12V / 0.25W / 2800K, 5000K

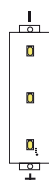
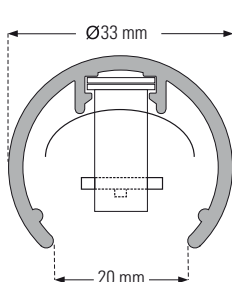
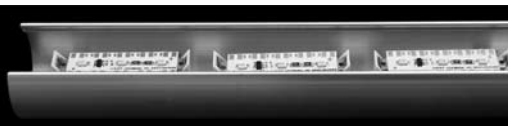

Données et puissances - Daten und Leistungen - Power and other data

Réf.	Lenght	N° of lighting units	Volt	Power
TMT-AL-0670	670mm	10	12V	2.5W
TMT-AL-1000	1000mm	16	12V	4W
TMT-AL-0000 fabriqué sur mesure - prix sur demande / Massanfertigung - Preise auf Anfrage / made to measure - price on request				

AGA-LED® B-3 luminous flux:

2800K: **9 lm**

5000K: **10,5 lm**

TMT-AL IP20

AGA-LED® B-6 RIGID LOOP CONNECTOR

24V / 0.5W / 2800K, 5000K

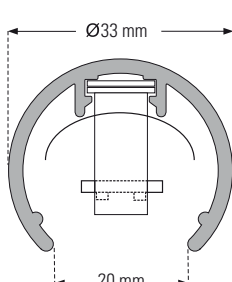

Données et puissances - Daten und Leistungen - Power and other data

Réf.	Lenght	N° of lighting units	Volt	Power
TMT-AL-0670	670mm	10	24V	5W
TMT-AL-1000	1000mm	16	24V	8W
TMT-AL-0000 fabriqué sur mesure - prix sur demande / Massanfertigung - Preise auf Anfrage / made to measure - price on request				

AGA-LED® B-6 luminous flux:

2800K: **18 lm**

5000K: **21 lm**

TMT-AL IP20

AGA-LED® B-10 RIGID LOOP CONNECTOR

24V / 1W / 2800K, 5000K

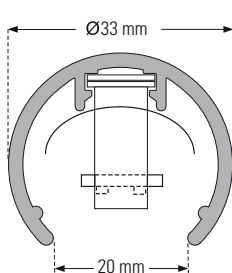

Données et puissances - Daten und Leistungen - Power and other data

Réf.	Lenght	N° of lighting units	Volt	Power
TMT-AL-0670	670mm	10	24V	10W
TMT-AL-1000	1000mm	16	24V	16W
TMT-AL-0000 fabriqué sur mesure - prix sur demande / Massanfertigung - Preise auf Anfrage / made to measure - price on request				

AGA-LED® B-10 luminous flux:

2800K: **31 lm**

5000K: **35 lm**



IP20



Prix: voir référence ou nom dans la liste de prix
Preise: Siehe Artikel-Nr. oder Modellbezeichnung in der Preisliste
Price: see under reference or name in price list

AGA-LED® lighting units
USA, Europe, Japan patents

SYSTÈME ÉCLAIRAGE TABLEAU AGA-LED®

BILDERBELEUCHTUNGSSYSTEM AGA-LED®

AGA-LED® PICTURE LIGHTING SYSTEM

TMT-AL IP20

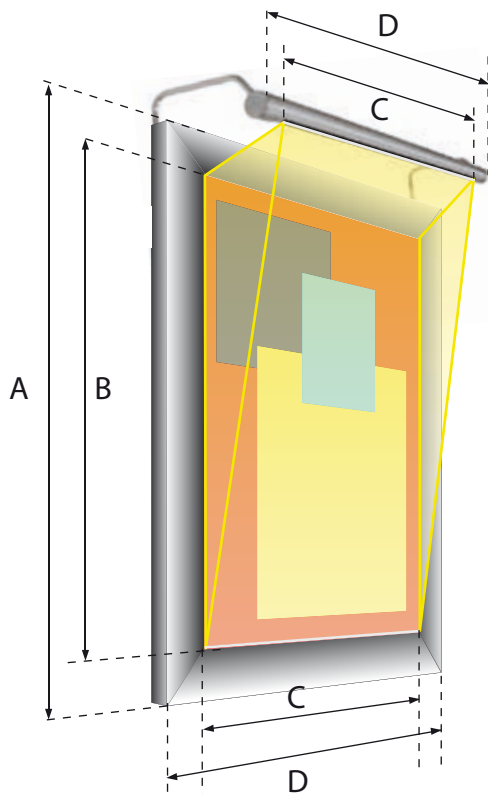
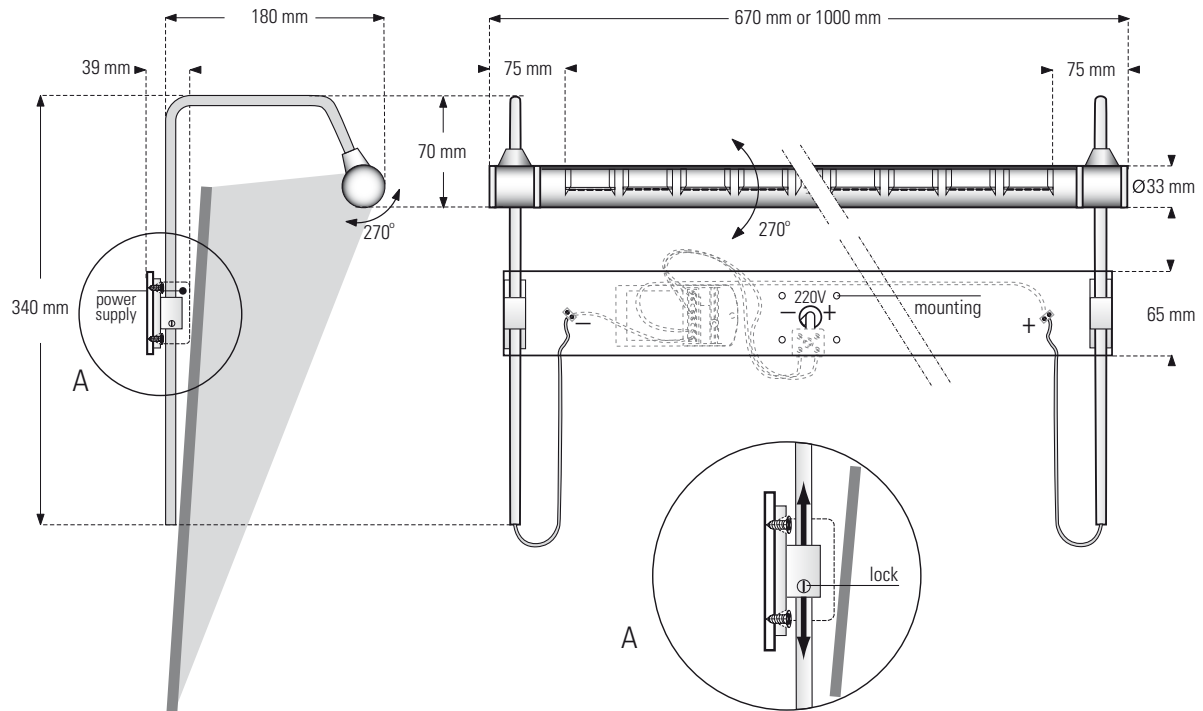







- La mesure **C** correspond à la zone d'éclairage.
Das Mass **C** entspricht dem Leuchtbereich.
Measurement **C** is the area lit.
- La mesure **D** correspond à la dimension externe du cadre.
Das Mass **D** entspricht der Aussenabmessung des Rahmens.
Measurement **D** is the outside dimensions of the frame.

ACCESSOIRES POUR SYSTÈME ÉCLAIRAGE TABLEAU AGA-LED®

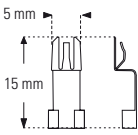
ZUBEHÖR FÜR DAS BILDERBELEUCHTUNGSSYSTEM AGA-LED®

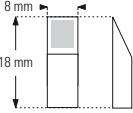
ACCESSORIES FOR AGA-LED® PICTURE LIGHTING SYSTEM

TMT-AL IP20

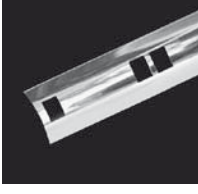
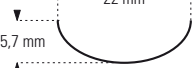
				TMT-AL									
BXA		<ul style="list-style-type: none"> ▪ Support pour AGA-LED® rigid loop connector ▪ Halter für AGA-LED® rigid loop connector ▪ Holder for AGA-LED® rigid loop connector 		●									
CMB		<ul style="list-style-type: none"> ▪ Cache pour support BXA ▪ Sichtabdeckung für BXA-Halter ▪ White shroud for BXA 		●									
BFTV-8		<ul style="list-style-type: none"> ▪ Fixation verticale murale pour tige ▪ Vertikale Wandbefestigung für Bügel ▪ Vertical wall mounting for rods 		●									
TIGE-8		<ul style="list-style-type: none"> ▪ Tige de support long. 340mm Ø8mm ▪ Haltebügel Länge 340mm Ø8mm ▪ Rod support length 340mm Ø8mm 		●									
TMTE		<ul style="list-style-type: none"> ▪ Embout aluminium ▪ Aluminium-Endstücke ▪ Aluminium end-cap 		●									
RIP		<ul style="list-style-type: none"> ▪ Réflecteur intensif ▪ Intensivreflektor ▪ Small narrow intensive reflector 		<table border="1" style="width: 100%; border-collapse: collapse;"> <thead> <tr> <th style="text-align: left;">Code</th> <th style="text-align: left;">Lenght</th> </tr> </thead> <tbody> <tr> <td>RIP-0670</td> <td>670mm</td> </tr> <tr> <td>RIP-1000</td> <td>1000mm</td> </tr> <tr> <td>RIP-0000</td> <td>made to measure</td> </tr> </tbody> </table>	Code	Lenght	RIP-0670	670mm	RIP-1000	1000mm	RIP-0000	made to measure	●
Code	Lenght												
RIP-0670	670mm												
RIP-1000	1000mm												
RIP-0000	made to measure												

● Compris dans le luminaire
Die Leuchteneinführung umfasst
Included

●● Non compris dans le luminaire
Die Leuchteneinführung umfasst nicht
Not included

Prix: voir référence ou nom dans la liste de prix
Preise: Siehe Artikel-Nr. oder Modellbezeichnung in der Preisliste
Price: see under reference or name in price list

AGA-LED® lighting units
USA, Europe, Japan patents